

# DTP HDMI 330 • Setup Guide

This guide provides quick start instructions for an experienced installer to set up and operate the Extron DTP HDMI 330 digital video extender. The DTP HDMI 330 transmitter and receiver pair can extend an HDCP-compliant HDMI signal up to 330 feet (100 m).

**IMPORTANT:**  
Refer to [www.extron.com](http://www.extron.com) for the complete user guide, installation instructions, and specifications before connecting the product to the power source.

## Installation

### Step 1 — Mounting

Turn off or disconnect all equipment power sources and mount the Tx and Rx units as required.

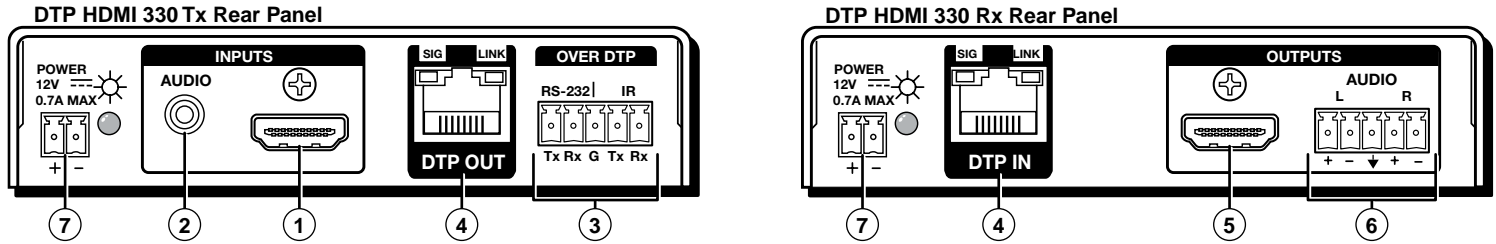

### Step 2 — Connections

- HDMI Input connector (Tx)** — Connect an HDMI cable between this port and the HDMI output port of the digital video source.

**NOTE:** See "LockIt™ Lacing Brackets" on the back of this guide for to securely fasten the input HDMI connector to the transmitter.

- Audio input (Tx)** — Connect an unbalanced stereo audio source to this 3.5 mm mini stereo jack for an analog audio input.
- RS-232 and IR connectors** — To pass serial or infrared data or control signals, such as serial control of a projector, connect the master device to the transmitter and the slave device to the receiver via the RS-232 and IR captive screw connectors on both units.
- DTP RJ-45 connectors** — Connect transmitter DTP Out to receiver DTP In. Extron recommends that you terminate both cable ends in accordance with the following specifications, at a minimum:
  - TIA/EIA T 568 B
  - CAT 6A, shielded
  - 24 AWG, solid conductor

**ATTENTION:** Do not connect these devices to a computer data or telecommunications network.

**Signal LED** — Lights when the unit is receiving a clock signal on the HDMI input (for the transmitter) or any valid signal on the DTP In connector (for the receiver).

**Link LED** — Lights when a valid link is established between the units on the DTP cable.

- HDMI Output connector (Rx)** — Connect a display with an HDMI input for display of the transmitted direct digital image.

**NOTE:** See the "LockIt™ Lacing Brackets" on the back of this guide for to securely fasten the output HDMI connector to the receiver.

- Audio Output connector (Rx)** — Connect a balanced or unbalanced stereo or mono audio device to the receiver via the Audio captive screw connector. See the drawing below.

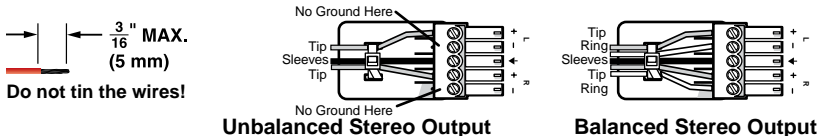

**ATTENTION:** Connect the sleeves to the ground contact. **DO NOT** connect the sleeves to the negative (-) contacts.

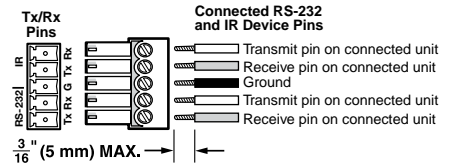
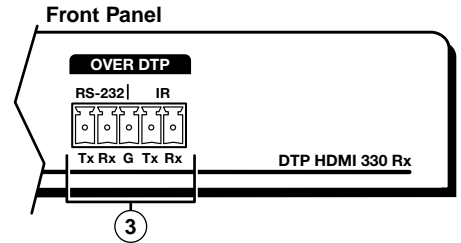

Pin	TIA/EIA T 568 B Wire color
1	White-orange
2	Orange
3	White-green
4	Blue
5	White-blue
6	Green
7	White-brown
8	Brown

# DTP HDMI 330 • Setup Guide (Continued)

- ⑦ **Power connector** — Connect an IEC power cord between the included 12 VDC power supply and a 100-240 VAC, 50-60 Hz source. Connect the power supply to either unit as shown at right. Use the included tie-wrap to strap the cord to the captive screw connector.

**NOTE:** Only one power supply is required. A single power supply connected to either unit in the pair powers both units. A power supply is included with each transmitter.

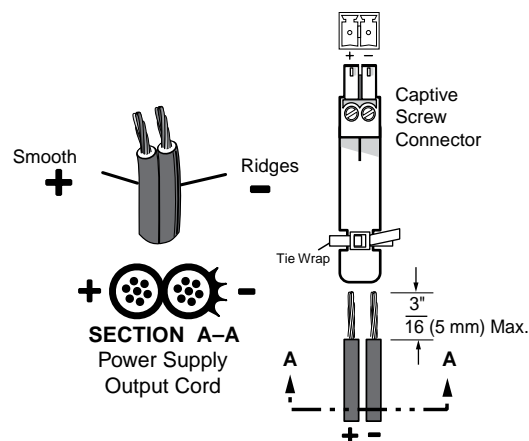

## Operation

After all devices are powered up, the system is fully operational. See the definitions of the power indications (shown at right), below:

- ① **Power LED (front panel)** —

**Amber** — The unit is receiving power, either locally or remotely (on the DTP cable).

**Green** — The unit is powered on and is receiving an active HDMI signal, either on the HDMI input if a transmitter, or transmitted on the DTP cable if a receiver.

- ② **Power LED (rear panel)** —

**Amber** — The unit is receiving power remotely (on the DTP cable).

**Green** — The unit is receiving power locally.

If any problems are encountered, verify that the cables are routed and connected properly. If your problems persist, call the Extron S3 Sales and Technical Support Hotline that is closest to you, at the number shown below.

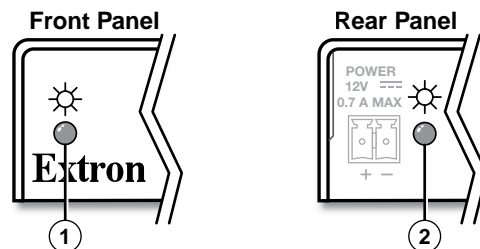

## LockIt™ Lacing Brackets

Use an included LockIt Lacing Bracket to securely fasten an HDMI cable to each device as follows.

1. Plug the HDMI cable into the panel connection.
2. Loosen the HDMI connection mounting screw from the panel enough to allow the LockIt lacing bracket to be placed over it. The screw does not have to be removed.
3. Place the LockIt lacing bracket on the screw and against the HDMI connector, then tighten the screw to secure the bracket.

**ATTENTION:** Do not overtighten the HDMI connector mounting screw. The shield it fastens to is very thin and can easily be stripped.

4. Loosely place the included tie wrap around the HDMI connector and the LockIt lacing bracket as shown.
5. While holding the connector securely against the lacing bracket, use pliers or similar tools to tighten the tie wrap, then remove any excess length.

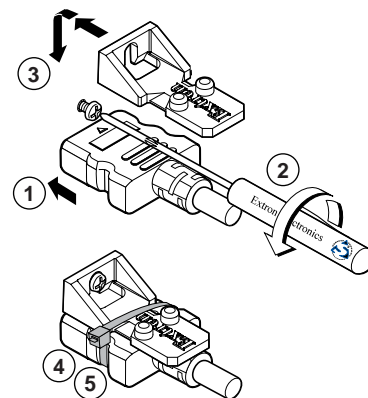

<b>Extron Headquarters</b> +1.800.633.9876 (Inside USA/Canada Only) Extron USA - West      Extron USA - East +1.714.491.1500      +1.919.850.1000 +1.714.491.1517 FAX      +1.919.850.1001 FAX	<b>Extron Europe</b> +800.3987.6673 (Inside Europe Only) +31.33.453.4040 +31.33.453.4050 FAX	<b>Extron Asia</b> +800.7339.8766 (Inside Asia Only) +65.6383.4400 +65.6383.4664 FAX	<b>Extron Japan</b> +81.3.3511.7655 +81.3.3511.7656 FAX	<b>Extron China</b> +4000.398766 Inside China Only +86.21.3760.1568 +86.21.3760.1566 FAX	<b>Extron Middle East</b> +971.4.2991800 +971.4.2991880 FAX	<b>Extron Korea</b> +82.2.3444.1571 +82.2.3444.1575 FAX	<b>Extron India</b> 1800.3070.3777 Inside India Only +91.80.3055.3777 +91.80.3055.3737 FAX
--	--	--	---	--	---	---	--